

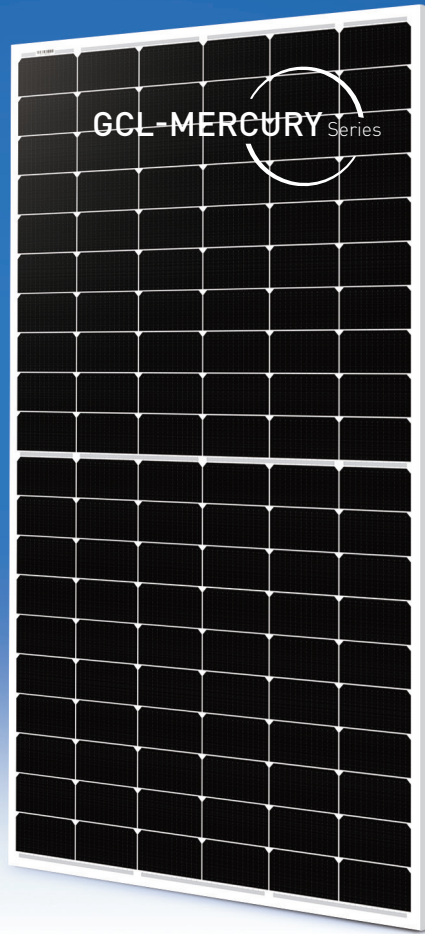

GCL-M3/72 GCL-M3/72H Monocrystalline Module 340-375W



375W

Maximum Power Output

19.0%

Maximum Module Efficiency

0~+5W

Power Output Guarantee

Cell Type

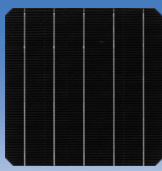

5BB

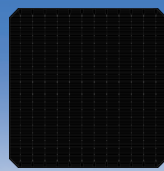

MBB



Ideal choice for large scale ground installation



Selected encapsulating material and stringent production process control ensure the product is highly PID resistant and snail trails free



Special cutting and soldering technology leads to low hotspot risk



Sand blowing test, salt mist test and ammonia test passed to endure harsh environments



Optimized system performance due to module level current sorting

Company Introduction

GCL System Integration Technology Co. Ltd (002506 Shenzhen Stock) (GCL System) is part of GOLDEN CONCORD Group (GCL) which is an international energy company specializing in clean and sustainable power production. The group, founded in 1990 now employs 30,000 people.

GCL Delivers Reliable Performance Over Time

- World-class manufacturer of crystalline silicon photovoltaic modules
- Fully automatic facility and world-class technology
- Rigorous quality control to meet the highest standard: ISO9001:2008, ISO 14001: 2004 and OHSAS: 18001 2007
- Tested for harsh environments (salt mist, ammonia corrosion and sand blowing test: IEC 61701, IEC 62716, DIN EN 60068-2- 68)
- Long term reliability tests
- 2*100% EL inspection ensuring defect-free modules

Linear Performance Warranty

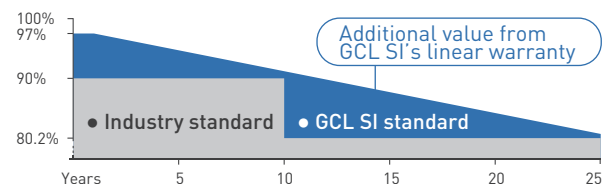

10 Years Product Warranty 25 Years Linear Power Warranty

* Please refer to GCL standard warranty for details

Additional Insurance Backed by Swiss RE



* Please refer to GCL for details

GCL-M3/72 GCL-M3/72H

GCL-Mercury Series Monocrystalline Module

340-375W

Electrical Specification (STC)

Maximum Power	P _{max} (W)	340	345	350	355	360	365	370	375
Maximum Power Voltage	V _{mp} (V)	38.61	38.84	39.11	39.40	39.70	40.00	40.30	40.60
Maximum Power Current	I _{mp} (A)	8.81	8.88	8.95	9.01	9.07	9.13	9.18	9.24
Short Circuit Current	I _{sc} (A)	9.40	9.49	9.54	9.59	9.63	9.67	9.71	9.75
Open Circuit Voltage	V _{oc} (V)	46.65	46.88	47.12	47.32	47.52	47.73	47.93	48.13
Module Efficiency	(%)	17.3	17.5	17.8	18.0	18.3	18.5	18.8	19.0
Power Output Tolerance	(W)	0~+5							

* Irradiance 1000W/m², Module Temperature 25°C, Air Mass 1.5

Electrical Specification (NOCT)

Maximum Power	P _{max} (W)	251.69	254.89	259.19	262.08	265.35	268.64	272.69	276.02
Maximum Power Voltage	V _{mp} (V)	35.30	35.50	35.80	36.00	36.30	36.60	36.90	37.20
Maximum Power Current	I _{mp} (A)	7.13	7.18	7.24	7.28	7.31	7.34	7.39	7.42
Short Circuit Current	I _{sc} (A)	7.60	7.67	7.71	7.75	7.78	7.82	7.85	7.88
Open Circuit Voltage	V _{oc} (V)	43.10	43.30	43.50	43.70	43.90	44.10	44.20	44.40

Mechanical Data

Solar Cell Type	Mono 78.38×156.75 mm
Number of Cells	144 Cells (6×24)
Dimensions of Module L*W*H (mm)	1986×992×35 mm (78.19×39.1×1.38 inches)
Weight (kg)	22.6 kg
Glass	High transparency solar glass 3.2mm (0.13 inches)
Backsheet	White
Frame	Silver, anodized aluminium alloy
J-Box	IP67 Rated
Cable	4.0mm ² (0.006 inches ²), 300mm (11.8 inches)
Number of diodes	3
Wind/ Snow Load	2400Pa/5400Pa*
Connector	MC4 Compatible

* For more details please check the installation manual of GCLSI

Temperature Ratings

Nominal Operating Cell Temperature (NOCT)	45±2°C
Temperature Coefficient of P _{MAX}	-0.41%/°C
Temperature Coefficient of V _{oc}	-0.31%/°C
Temperature Coefficient of I _{sc}	+0.055%/°C

Maximum Ratings

Operational Temperature	-40~+85°C
Maximum System Voltage	1000V DC
	1500V DC-(H)
Max Series Fuse Rating	15A

Packaging Configuration

Module per box	30 pieces
Module per 40' container	660 pieces

Optional

Connector: Original MC4



Contact Us for More Information

website: en.gclsi.com email: gclsisales@gclsi.com

Module Dimension

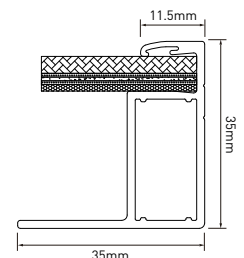
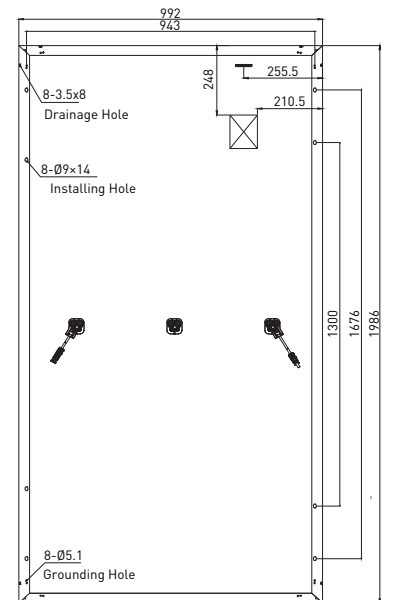

U-I Curve at Different Temperature (365W)

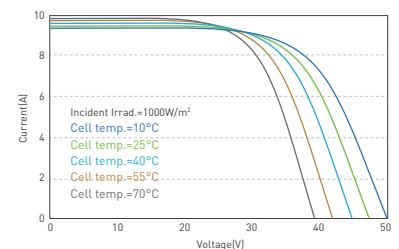

U-I/P-U Curve at Different Irradiation (365W)

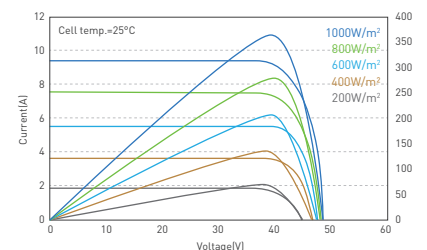

CAUTION: READ INSTALLATION MANUAL BEFORE USING THE PRODUCT